

512K x 24 Static RAM

Features

- **High speed**
— $t_{AA} = 8 \text{ ns}$
- **Low active power**
— 1080 mW (max.)
- **Operating voltages of $3.3 \pm 0.3\text{V}$**
- **2.0V data retention**
- **Automatic power-down when deselected**
- **TTL-compatible inputs and outputs**
- **Easy memory expansion with \overline{CE}_0 , \overline{CE}_1 and \overline{CE}_2 features**
- **Available in non Pb-free 119 ball PBGA.**

Functional Description

The CY7C1012AV33 is a high-performance CMOS static RAM organized as 512K words by 24 bits. Each data byte is separately controlled by the individual chip selects (\overline{CE}_0 , \overline{CE}_1 , \overline{CE}_2). \overline{CE}_0 controls the data on the I/O_0 – I/O_7 , while \overline{CE}_1 controls the data on I/O_8 – I/O_{15} , and \overline{CE}_2 controls the data on the data pins I/O_{16} – I/O_{23} . This device has an automatic

power-down feature that significantly reduces power consumption when deselected.

Writing the data bytes into the SRAM is accomplished when the chip select controlling that byte is LOW and the write enable input (\overline{WE}) input is LOW. Data on the respective input/output (I/O) pins is then written into the location specified on the address pins (A_0 – A_{18}). Asserting all of the chip selects LOW and write enable LOW will write all 24 bits of data into the SRAM. Output enable (\overline{OE}) is ignored while in WRITE mode.

Data bytes can also be individually read from the device. Reading a byte is accomplished when the chip select controlling that byte is LOW and write enable (\overline{WE}) HIGH while output enable (\overline{OE}) remains LOW. Under these conditions, the contents of the memory location specified on the address pins will appear on the specified data input/output (I/O) pins. Asserting all the chip selects LOW will read all 24 bits of data from the SRAM.

The 24 I/O pins (I/O_0 – I/O_{23}) are placed in a high-impedance state when all the chip selects are HIGH or when the output enable (\overline{OE}) is HIGH during a READ mode. For further details, refer to the truth table of this data sheet.

The CY7C1012AV33 is available in a standard 119-ball PBGA.

Functional Block Diagram

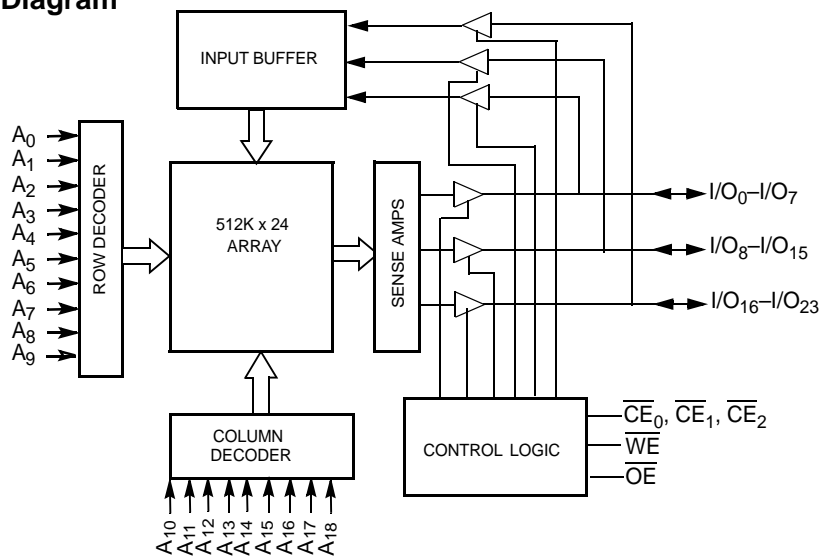

Selection Guide

		-8	-10	Unit
Maximum Access Time		8	10	ns
Maximum Operating Current	Commercial	300	275	mA
	Industrial	300	275	
Maximum CMOS Standby Current	Commercial/Industrial	50	50	mA

Pin Configurations^[1, 2]
**119 PBGA
Top View**

	1	2	3	4	5	6	7
A	NC	A	A	A	A	A	NC
B	NC	A	A	\overline{CE}_0	A	A	NC
C	I/O ₁₂	NC	\overline{CE}_1	NC	\overline{CE}_2	NC	I/O ₀
D	I/O ₁₃	V _{DD}	V _{SS}	V _{SS}	V _{SS}	V _{DD}	I/O ₁
E	I/O ₁₄	V _{SS}	V _{DD}	V _{SS}	V _{DD}	V _{SS}	I/O ₂
F	I/O ₁₅	V _{DD}	V _{SS}	V _{SS}	V _{SS}	V _{DD}	I/O ₃
G	I/O ₁₆	V _{SS}	V _{DD}	V _{SS}	V _{DD}	V _{SS}	I/O ₄
H	I/O ₁₇	V _{DD}	V _{SS}	V _{SS}	V _{SS}	V _{DD}	I/O ₅
J	NC	V _{SS}	V _{DD}	V _{SS}	V _{DD}	V _{SS}	DNU
K	I/O ₁₈	V _{DD}	V _{SS}	V _{SS}	V _{SS}	V _{DD}	I/O ₆
L	I/O ₁₉	V _{SS}	V _{DD}	V _{SS}	V _{DD}	V _{SS}	I/O ₇
M	I/O ₂₀	V _{DD}	V _{SS}	V _{SS}	V _{SS}	V _{DD}	I/O ₈
N	I/O ₂₁	V _{SS}	V _{DD}	V _{SS}	V _{DD}	V _{SS}	I/O ₉
P	I/O ₂₂	V _{DD}	V _{SS}	V _{SS}	V _{SS}	V _{DD}	I/O ₁₀
R	I/O ₂₃	A	NC	NC	NC	A	I/O ₁₁
T	NC	A	A	\overline{WE}	A	A	NC
U	NC	A	A	\overline{OE}	A	A	NC

Notes:

1. NC pins are not connected on the die.
2. DNU pins have to be left floating or tied to VSS to ensure proper application.

Maximum Ratings

(Above which the useful life may be impaired. For user guidelines, not tested.)

Storage Temperature -65°C to +150°C
 Ambient Temperature with Power Applied -55°C to +125°C
 Supply Voltage on V_{CC} to Relative GND^[3] -0.5V to +4.6V
 DC Voltage Applied to Outputs in High-Z State^[3] -0.5V to V_{CC} + 0.5V

DC Input Voltage^[3] -0.5V to V_{CC} + 0.5V
 Current into Outputs (LOW) 20 mA

Operating Range

Range	Ambient Temperature	V _{CC}
Commercial	0°C to +70°C	3.3V ± 0.3V
Industrial	-40°C to +85°C	

DC Electrical Characteristics Over the Operating Range

Parameter	Description	Test Conditions ^[4]	-8		-10		Unit
			Min.	Max.	Min.	Max.	
V _{OH}	Output HIGH Voltage	V _{CC} = Min., I _{OH} = -4.0 mA	2.4		2.4		V
V _{OL}	Output LOW Voltage	V _{CC} = Min., I _{OL} = 8.0 mA		0.4		0.4	V
V _{IH}	Input HIGH Voltage		2.0	V _{CC} + 0.3	2.0	V _{CC} + 0.3	V
V _{IL} ^[3]	Input LOW Voltage		-0.3	0.8	-0.3	0.8	V
I _{IX}	Input Leakage Current	GND ≤ V _I ≤ V _{CC}	-1	+1	-1	+1	μA
I _{OZ}	Output Leakage Current	GND ≤ V _{OUT} ≤ V _{CC} , Output Disabled	-1	+1	-1	+1	μA
I _{CC}	V _{CC} Operating Supply Current	V _{CC} = Max., f = f _{MAX} = 1/t _{RC}	Commercial	300		275	mA
			Industrial	300		275	mA
I _{SB1}	Automatic CE Power-down Current —TTL Inputs	Max. V _{CC} , CE ≥ V _{IH} , V _{IN} ≥ V _{IH} or V _{IN} ≤ V _{IL} , f = f _{MAX}		100		100	mA
I _{SB2}	Automatic CE Power-down Current —CMOS Inputs	Max. V _{CC} , CE ≥ V _{CC} - 0.3V, V _{IN} ≥ V _{CC} - 0.3V, or V _{IN} ≤ 0.3V, f = 0	Commercial /Industrial	50		50	mA

Capacitance^[5]

Parameter	Description	Test Conditions	Max.	Unit
C _{IN}	Input Capacitance	T _A = 25°C, f = 1 MHz, V _{CC} = 3.3V	8	pF
C _{OUT}	I/O Capacitance		10	pF

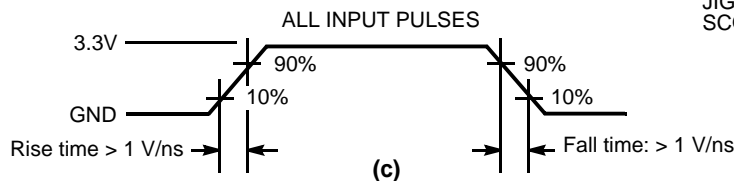
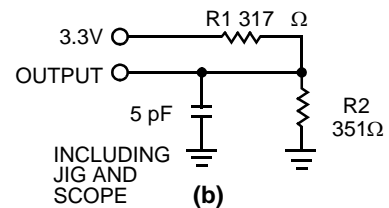
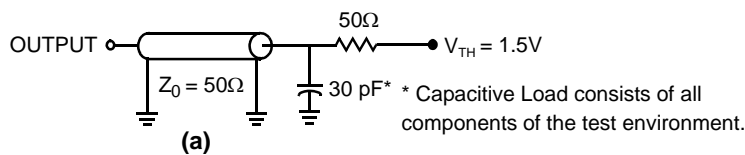
AC Test Loads and Waveforms^[6]

Notes:

- V_{IL} (min.) = -2.0V for pulse durations of less than 20 ns.
- CE refers to a combination of CE₀, CE₁, and CE₂. CE is active LOW when all three of these signals are active LOW at the same time.
- Tested initially and after any design or process changes that may affect these parameters.

AC Switching Characteristics Over the Operating Range^[7]

Parameter	Description	-8		-10		Unit
		Min.	Max.	Min.	Max.	
Read Cycle						
$t_{power}^{[8]}$	V_{CC} (typical) to the first access	1		1		ms
t_{RC}	Read Cycle Time	8		10		ns
t_{AA}	Address to Data Valid		8		10	ns
t_{OHA}	Data Hold from Address Change	3		3		ns
t_{ACE}	\overline{CE}_1 , \overline{CE}_2 , and \overline{CE}_3 LOW to Data Valid		8		10	ns
t_{DOE}	\overline{OE} LOW to Data Valid		5		5	ns
t_{LZOE}	\overline{OE} LOW to Low-Z ^[9]	1		1		ns
t_{HZOE}	\overline{OE} HIGH to High-Z ^[9]		5		5	ns
t_{LZCE}	\overline{CE}_1 , \overline{CE}_2 , and \overline{CE}_3 LOW to Low-Z ^[9]	3		3		ns
t_{HZCE}	\overline{CE}_1 , \overline{CE}_2 , or \overline{CE}_3 HIGH to High-Z ^[9]		5		5	ns
t_{PU}	\overline{CE}_1 , \overline{CE}_2 , and \overline{CE}_3 LOW to Power-up ^[10]	0		0		ns
t_{PD}	\overline{CE}_1 , \overline{CE}_2 , or \overline{CE}_3 HIGH to Power-down ^[10]		8		10	ns
t_{DBE}	Byte Enable to Data Valid		5		5	ns
t_{LZBE}	Byte Enable to Low-Z ^[9]	1		1		ns
t_{HZBE}	Byte Disable to High-Z ^[9]		5		5	ns
Write Cycle^[11, 12]						
t_{WC}	Write Cycle Time	8		10		ns
t_{SCE}	\overline{CE}_1 , \overline{CE}_2 , and \overline{CE}_3 LOW to Write End	6		7		ns
t_{AW}	Address Set-up to Write End	6		7		ns
t_{HA}	Address Hold from Write End	0		0		ns
t_{SA}	Address Set-up to Write Start	0		0		ns
t_{PWE}	\overline{WE} Pulse Width	6		7		ns
t_{SD}	Data Set-up to Write End	5		5.5		ns
t_{HD}	Data Hold from Write End	0		0		ns
t_{LZWE}	\overline{WE} HIGH to Low-Z ^[9]	3		3		ns
t_{HZWE}	\overline{WE} LOW to High-Z ^[9]		5		5	ns
t_{BW}	Byte Enable to End of Write	6		7		ns

Notes:

- Valid SRAM operation does not occur until the power supplies have reached the minimum operating V_{DD} (3.0V). As soon as 1 ms (T_{power}) after reaching the minimum operating V_{DD} , normal SRAM operation can begin including reduction in V_{DD} to the data retention (V_{CCDR} , 2.0V) voltage.
- Test conditions assume signal transition time of 3 ns or less, timing reference levels of 1.5V, input pulse levels of 0 to 3.0V, and output loading of the specified I_{OL}/I_{OH} and transmission line loads. Test conditions for the read cycle use output loading as shown in part a) of the AC test loads, unless specified otherwise.
- This part has a voltage regulator which steps down the voltage from 3V to 2V internally. t_{power} time has to be provided initially before a read/write operation is started.
- t_{HZOE} , t_{HZCE} , t_{HZWE} , t_{HZBE} , and t_{LZOE} , t_{LZCE} , t_{LZWE} , t_{LZBE} are specified with a load capacitance of 5 pF as in part (b) of AC Test Loads. Transition is measured ± 200 mV from steady-state voltage.
- These parameters are guaranteed by design and are not tested.

Switching Waveforms (continued)

Write Cycle No. 2 (\overline{WE} Controlled, \overline{OE} HIGH During Write)^[16, 17]

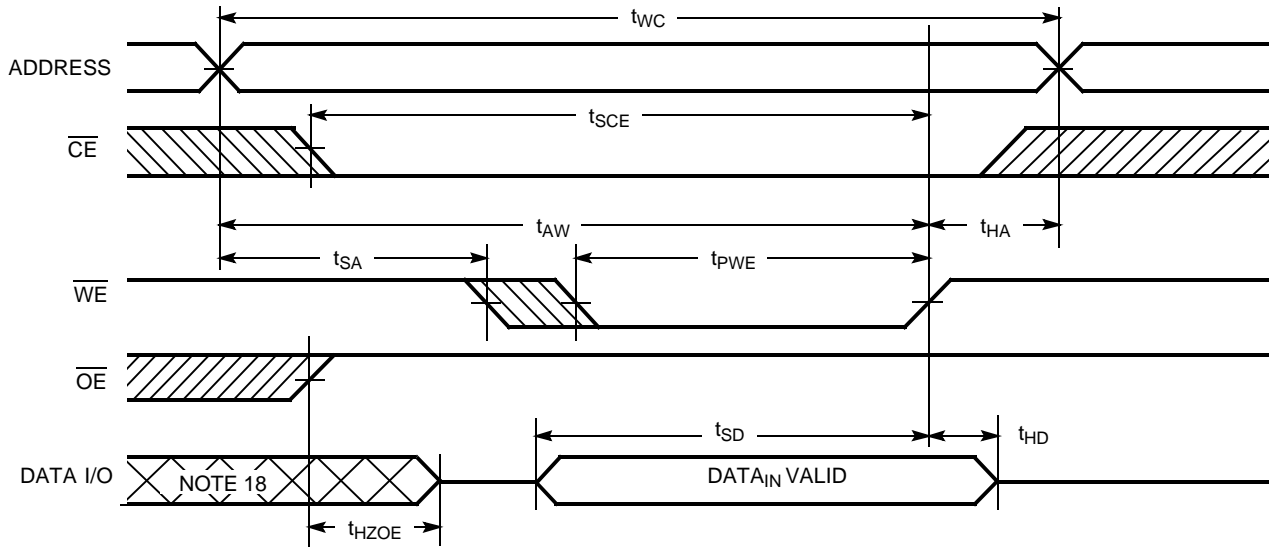

Write Cycle No. 3 (\overline{WE} Controlled, \overline{OE} LOW)^[4, 17]

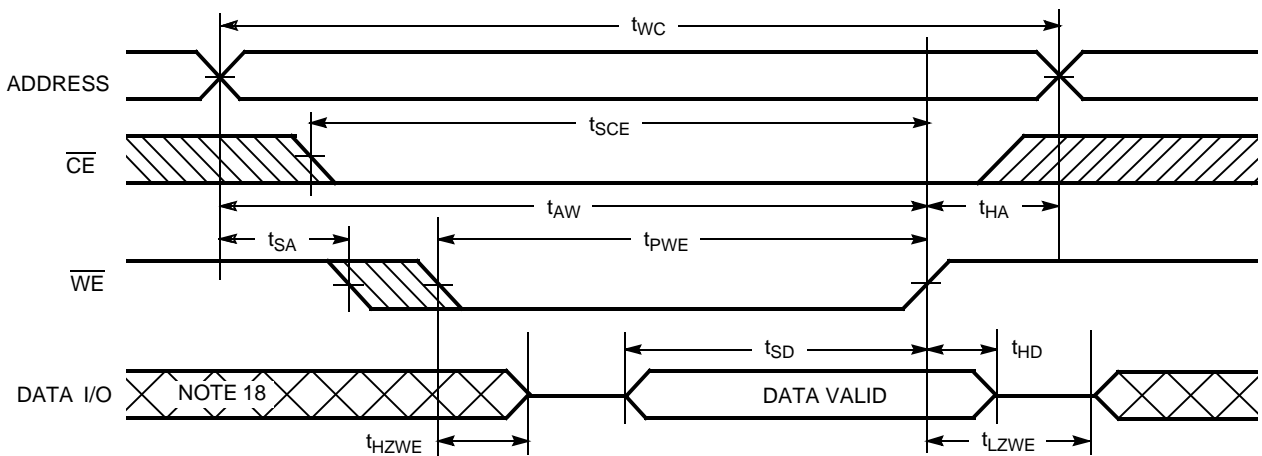

Notes:

- 16. Data I/O is high impedance if $\overline{OE} = V_{IH}$.
- 17. If \overline{CE} goes HIGH simultaneously with \overline{WE} going HIGH, the output remains in a high-impedance state.
- 18. During this period the I/Os are in the output state and input signals should not be applied.

Truth Table

\overline{CE}_0	\overline{CE}_1	\overline{CE}_2	\overline{OE}	\overline{WE}	I/O ₀ –I/O ₂₃	Mode	Power
H	H	H	X	X	High-Z	Power-down	Standby (I _{SB})
L	H	H	L	H	I/O ₀ –I/O ₇ Data Out	Read	Active (I _{CC})
H	L	H	L	H	I/O ₈ –I/O ₁₅ Data Out	Read	Active (I _{CC})
H	H	L	L	H	I/O ₁₆ –I/O ₂₃ Data Out	Read	Active (I _{CC})
L	L	L	L	H	Full Data Out	Read	Active (I _{CC})
L	H	H	X	L	I/O ₀ –I/O ₇ Data In	Write	Active (I _{CC})
H	L	H	X	L	I/O ₈ –I/O ₁₅ Data In	Write	Active (I _{CC})
H	H	L	X	L	I/O ₁₆ –I/O ₂₃ Data In	Write	Active (I _{CC})
L	L	L	X	L	Full Data In	Write	Active (I _{CC})
L	L	L	H	H	High-Z	Selected, Outputs Disabled	Active (I _{CC})

Ordering Information

Speed (ns)	Ordering Code	Package Diagram	Package Type	Operating Range
8	CY7C1012AV33-8BGC	51-85115	119-ball (14 x 22 x 2.4 mm) PBGA	Commercial
	CY7C1012AV33-8BGI			Industrial
10	CY7C1012AV33-10BGC			Commercial
	CY7C1012AV33-10BGI			Industrial

Package Diagram

119-ball PBGA (14 x 22 x 2.4 mm) (51-85115)

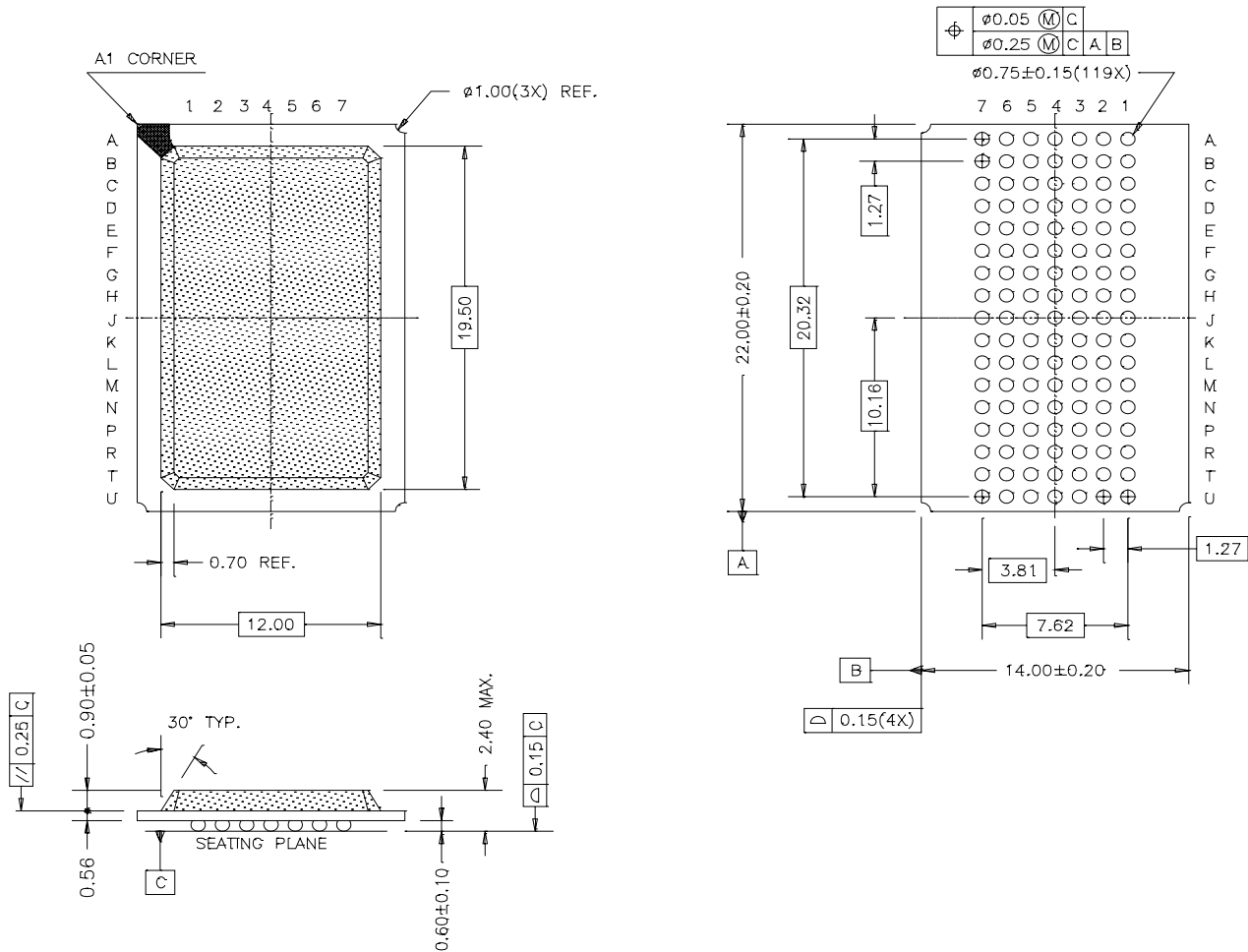

51-85115-B

All product and company names mentioned in this document may be the trademarks of their respective holders.

Document History Page

Document Title: CY7C1012AV33 512K x 24 Static RAM				
Document Number: 38-05254				
REV.	ECN NO.	Issue Date	Orig. of Change	Description of Change
**	113711	03/11/02	NSL	New Data Sheet
*A	117057	07/31/02	DFP	Removed 15-ns bin
*B	117988	09/03/02	DFP	Added 8-ns bin
*C	118992	09/19/02	DFP	Change Cin - input capacitance -from 6 pF to 8 pF Change Cout -output capacitance from 8 pF to 10 pF
*D	120382	11/15/02	DFP	Final data sheet. Added note 4 to "AC Test Loads and Waveforms"
*E	492137	See ECN	NXR	Removed 12 ns speed bin from product offering Included note #1 and 2 on page #2 Changed the description of I _{IX} from Input Load Current to Input Leakage Current in DC Electrical Characteristics table Updated Ordering Information Table